

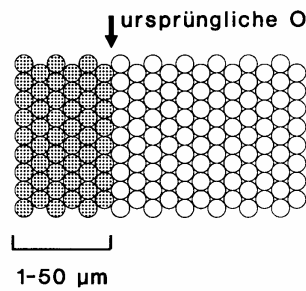

Atomic processes

Beschichtung



Ionenimplantation

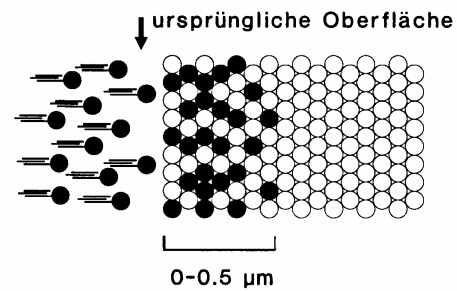

Ionenstrahlmischen

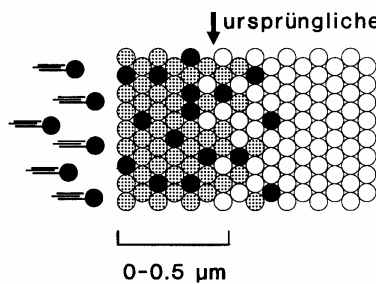

Ionenstrahlgestützte Beschichtung

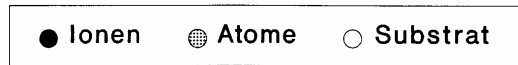
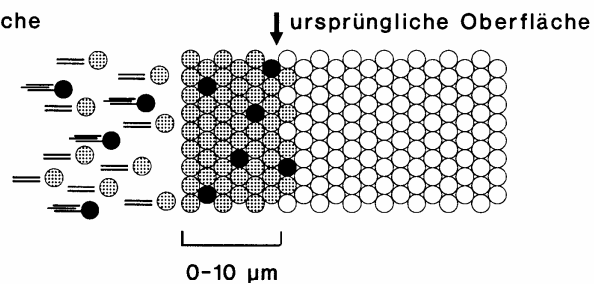

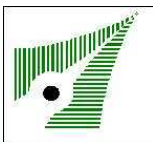

TRIM calculations

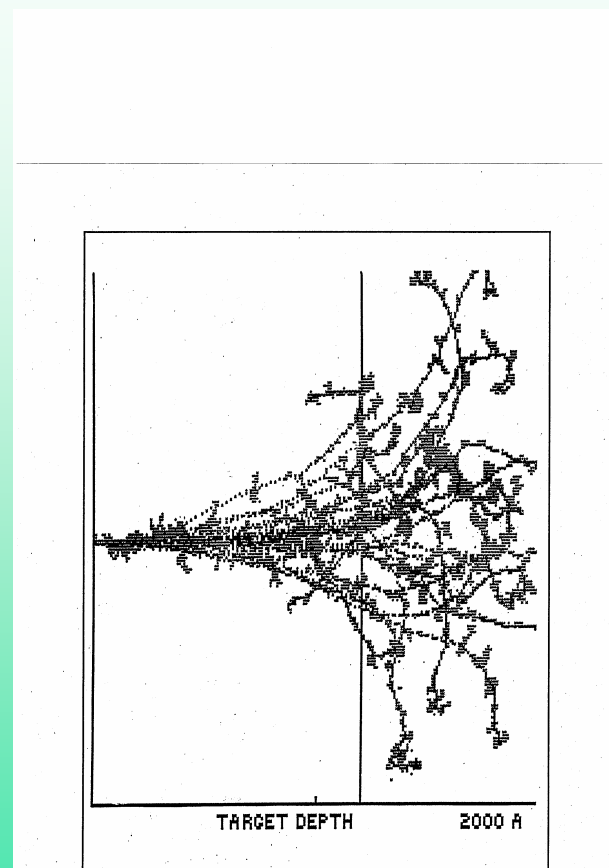
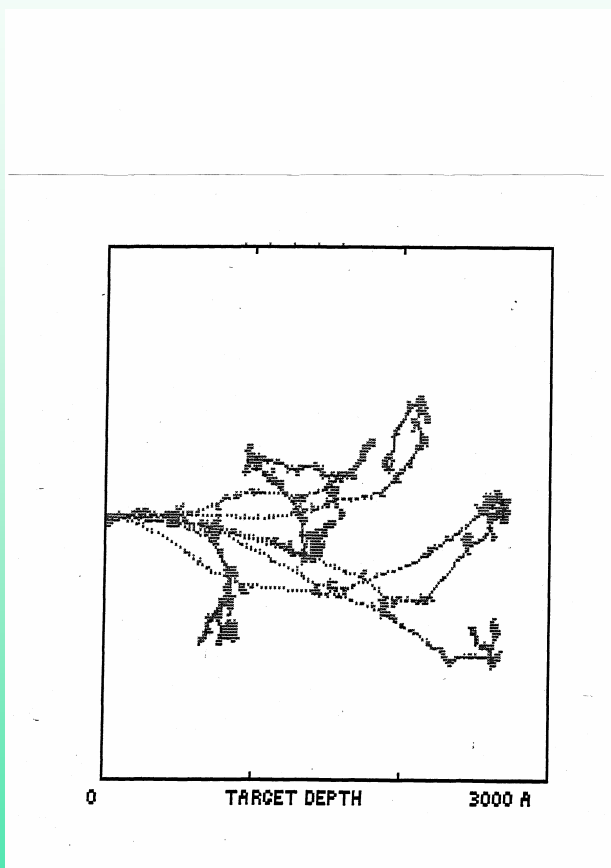



Plasma Immersion Ion Implantation

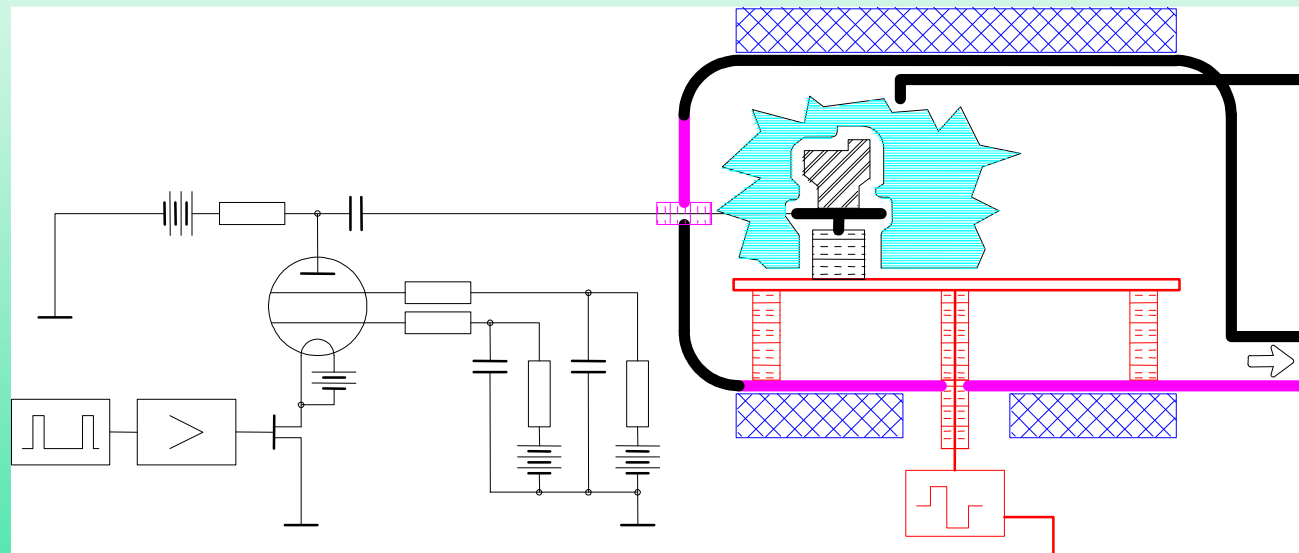



Materials for stents

- ASTM 316
- Nitinol
- alloys



Medical
Applications and
Technologies

Stent design



Torino, 18.04.2007

ACTECO, 2. Training Day



Medical
Applications and
Technologies

Stents, Details

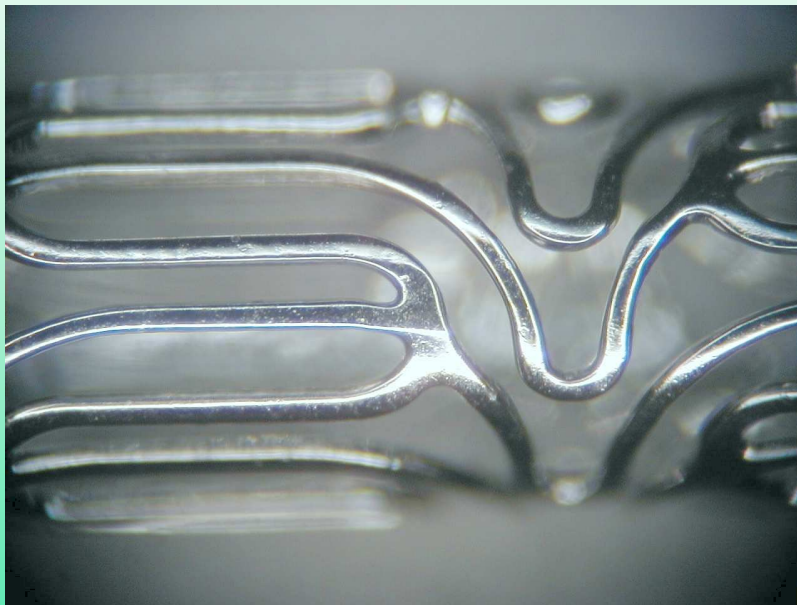

Torino, 18.04.2007

ACTECO, 2. Training Day



Medical
Applications and
Technologies

Stents, Details

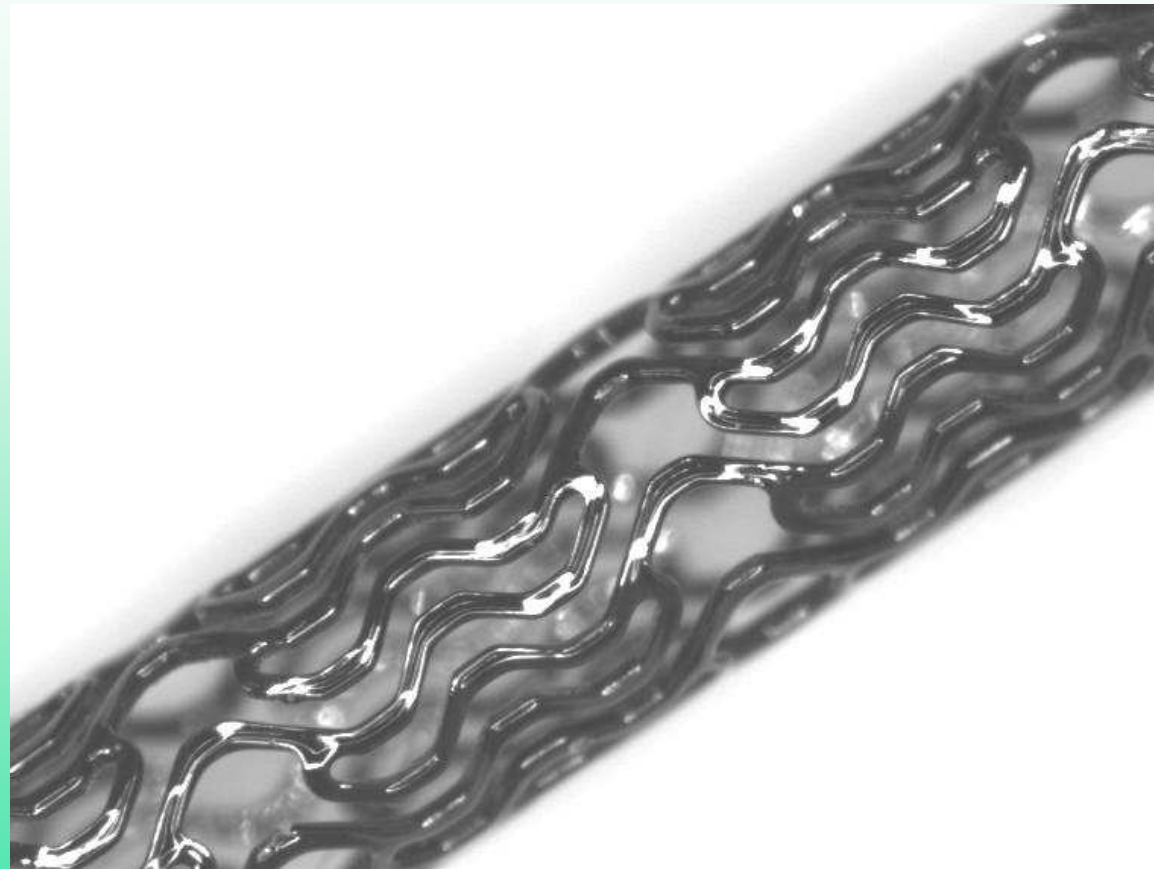

Torino, 18.04.2007

ACTECO, 2. Training Day



Medical
Applications and
Technologies

Stents, Details

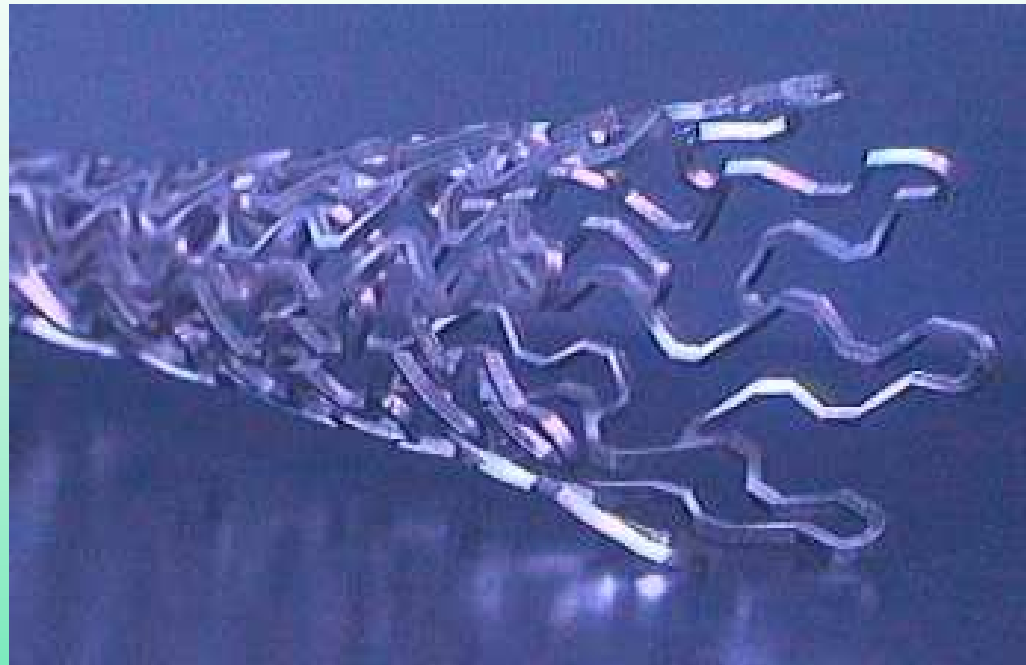

Torino, 18.04.2007

ACTECO, 2. Training Day



Expanded stent

